

d d

-
-
-
-

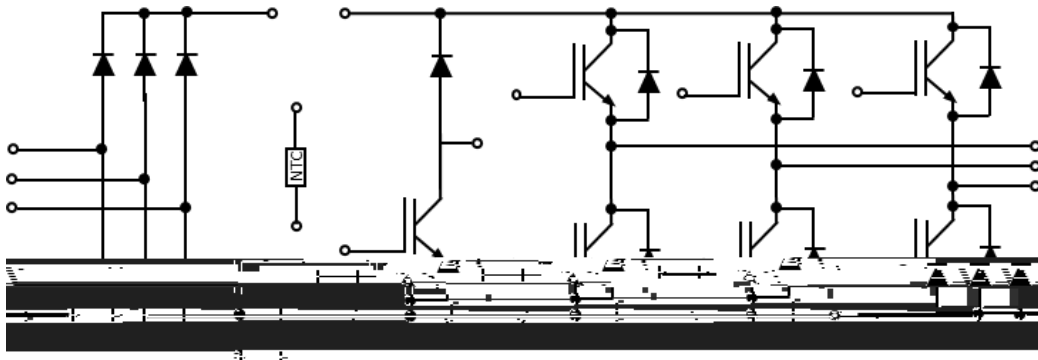

-
-
-
-

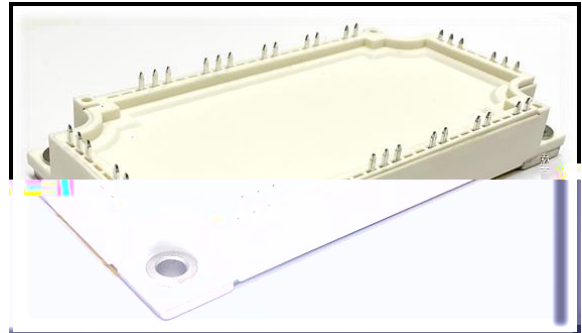

- _____

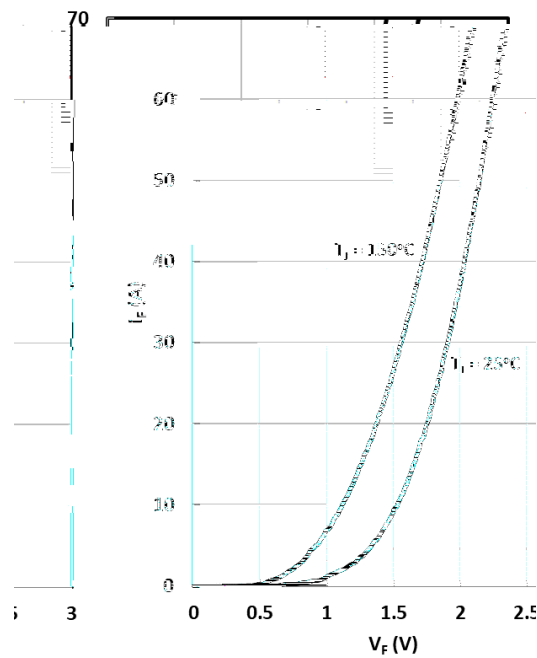
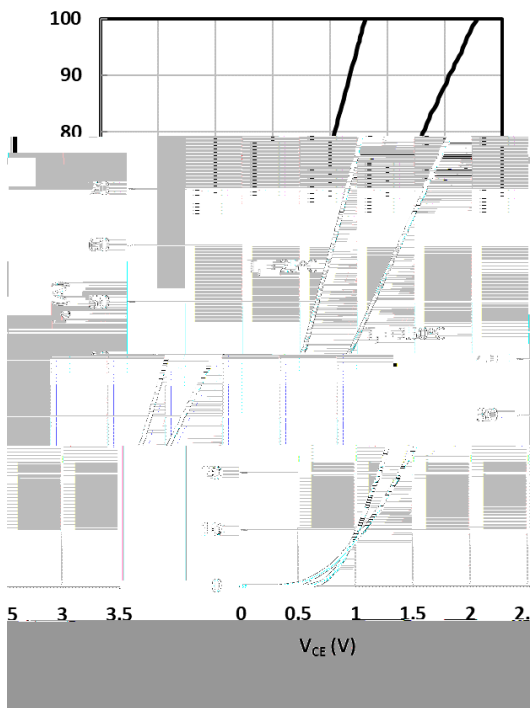
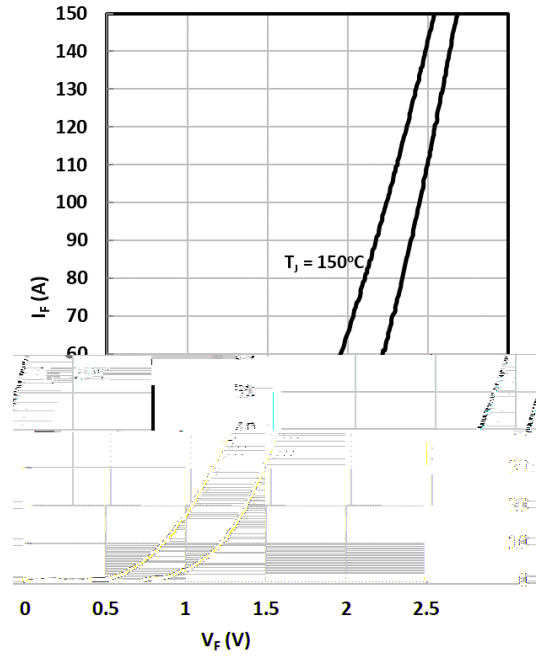
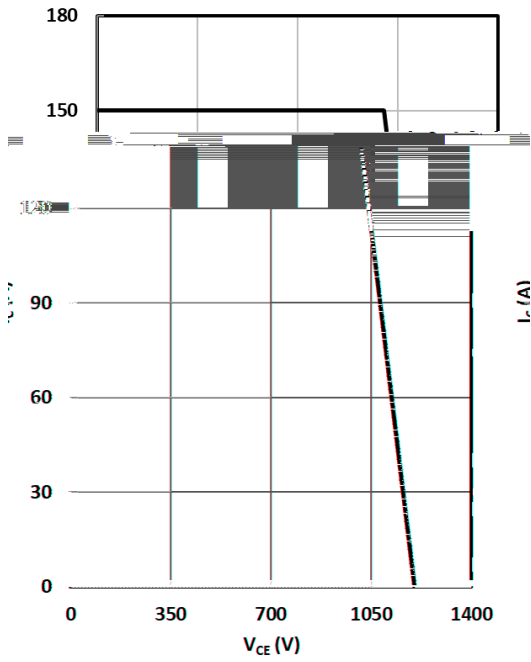

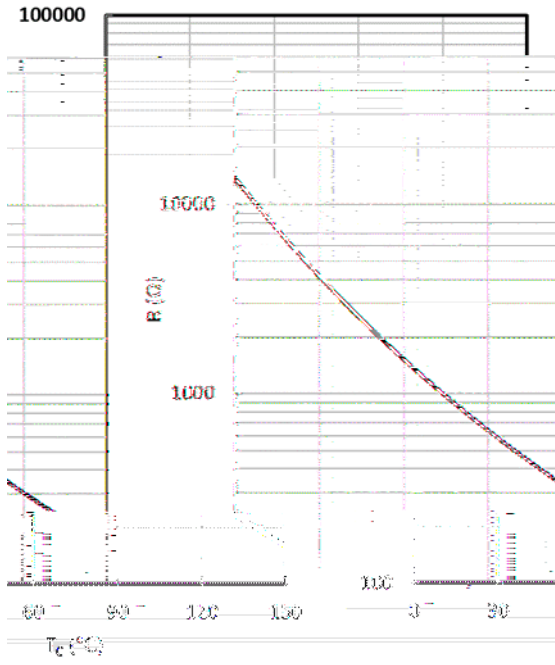

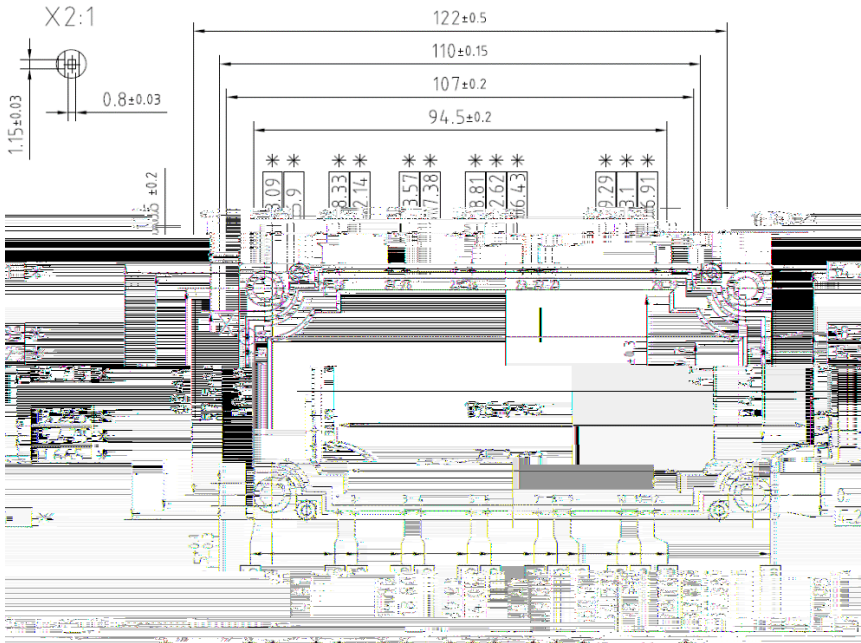
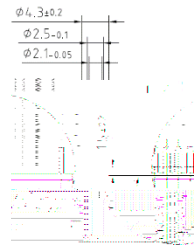
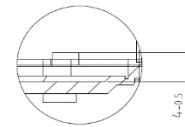
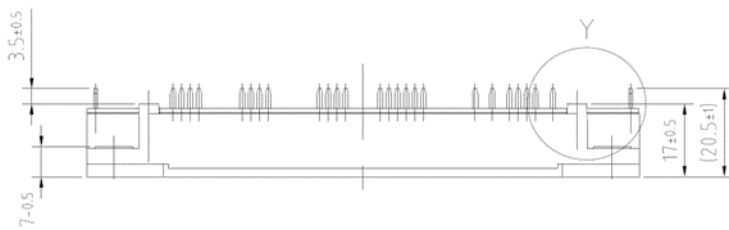
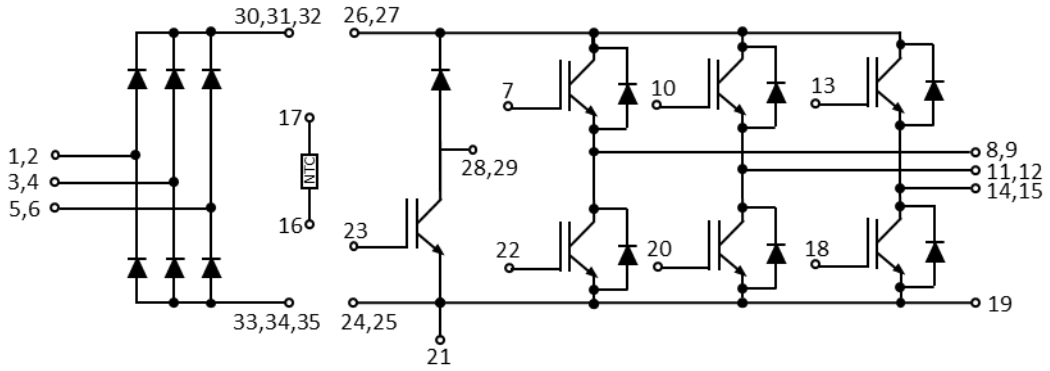

* = alle Maße mit einer Toleranz von ± 0.05 mm
* = all dimensions with a tolerance of ± 0.05 mm

